

***TECHNICAL  
INFORMATION***

---

**CITIZEN QUARTZ**

**Cal. No. 798 ※ ※**

 **CITIZEN**

## §1. OUTLINE

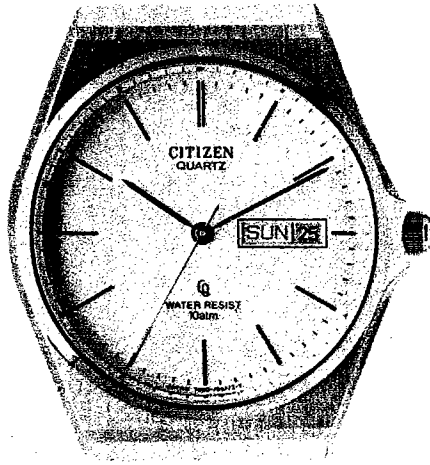

This watch for gentlemen is based on the mechanism of the 7930-series watches which were precedingly put on the market with addition of the calendar mechanism, thus increasing the varieties of the high-grade analog quartz watches featuring the ultra-thin gage structure.

Every calibrer of this watch boasts of its highest level in terms of both the performance and the interior specifications.

## §2. FEATURES

- 1) High-grade and ultra-thin gage analog quartz watch with calendar display for gentlemen's use.
- 2) Date display mechanism (Cal. No. 7990E)  
The quick setting device is incorporated.
- 3) Data and day display mechanism (Cal. No. 7980E)  
The day is displayed bilingually, with the quick setting device incorporated.
- 4) Power cell life indicating device  
The normal 1-second step movement of the second hand changes to the 2-second movement to indicate the end of the power cell life. The correct time is kept as usual even in that case.
- 5) Second hand stopping device  
With the crown pulled out two steps to the time setting position, the second hand can be stopped at an optional position to enable the correct time setting down to a second.  
At the same time, the power conservation switch is actuated. Thus, no current flows to the converter to save the power consumption although the quartz crystal oscillator is still operating.
- 6) Nominal power cell life of about 2 years  
Thanks to the high-performance converter as well as the electronic circuit of a low power consumption, just a single unit of the silver oxide power cell can keep the accurate time about 2 years.

## §3. SPECIFICATIONS

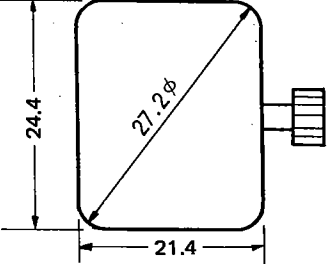
Caliber No.	7980E	7990E
Type	Analog-type quartz crystal watch with center second	←
Movement	Size: 24.4 x 21.4 x 27.2 mm $\phi$	←
	Thickness: 2.72mm	Thickness: 2.45mm
	Max. thickness: 2.97mm	Max. thickness: 2.70mm
		←
Accuracy	$\pm 5$ sec./month at normal temperature	←
Oscillation	32,768Hz	←
converter	Bipolar step motor	←
Integrated circuit	C/MOS-LSI (1 unit)	←
Effective temperature range	$-10^{\circ}\text{C} \sim +60^{\circ}\text{C}$ ( $14^{\circ}\text{F} \sim 140^{\circ}\text{F}$ )	←
Additional mechanisms	Date display (With quick setting device)	←
	Day display (With quick setting device)	Non
	Bilingual day switching device	Non
	Second hand stopping device at optional position	←
	Power saving switch	←
	Power cell life indicator	←
Power cell	280-27 (Silver oxide power cell)	←
	1.55V (Nominal voltage)	←
	Size : 11.6 $\phi$ x 2.1mm	←
	Capacity: 38mAH	←
	Life : About 2 years	←

§ 4. HANDLING INSTRUCTIONS

The handling instruction of this watch is identical to that of the conventional watches incorporating the date or day display mechanism.

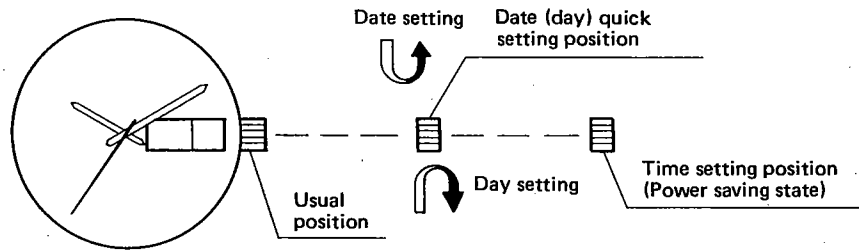

However, the time is set by turning the crown clockwise, which is opposite to other ordinary watches.

§ 5. STRUCTURE OF MOVEMENT

The operating mechanism of this watch is identical to the conventional analog quartz watches.

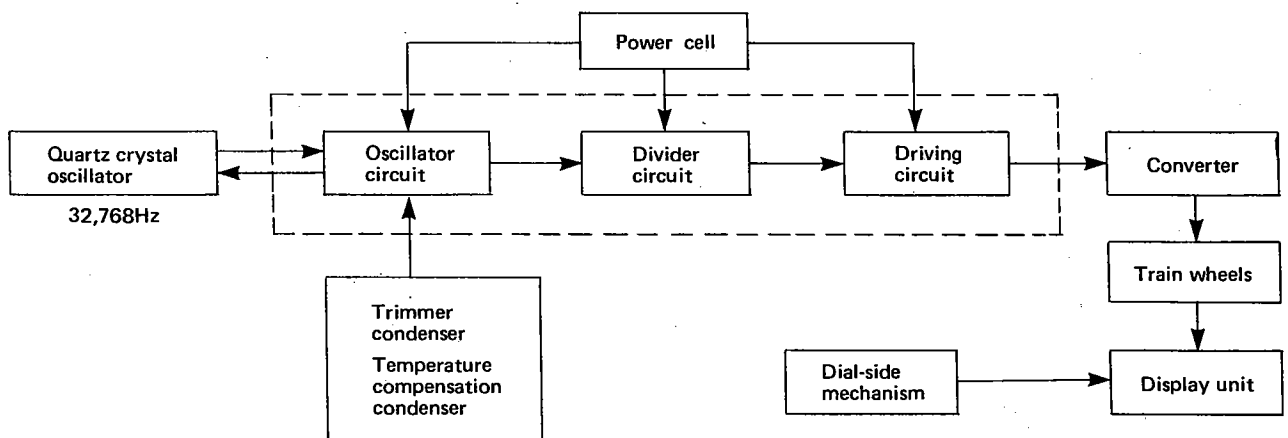

(Structural Diagram of Movement)

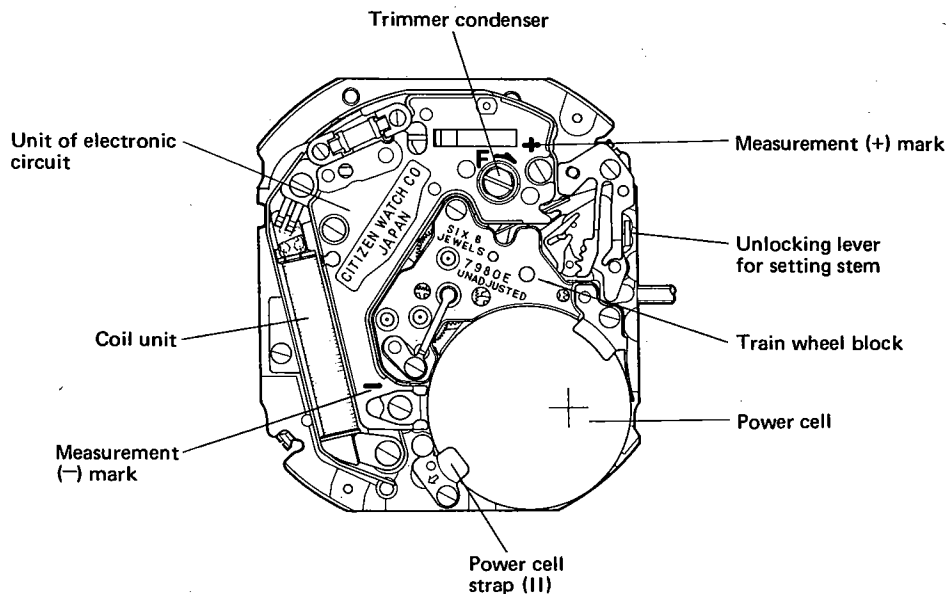

§ 6. DISASSEMBLING/ASSEMBLING PROCEDURE OF MOVEMENT

1) Dial side

Disassembling procedure: ① ~ ③⑤  
 Assembling procedure: ③⑤ ~ ①

Lubrication marks:  
 Ⓐ Synt-A-Lube oil  
 Ⓥ Synta-V-Lube oil  
 ∞ Citizen watch oil CH-1

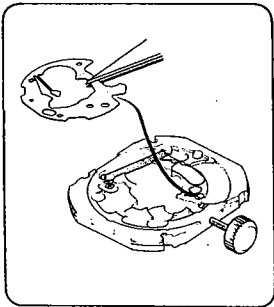
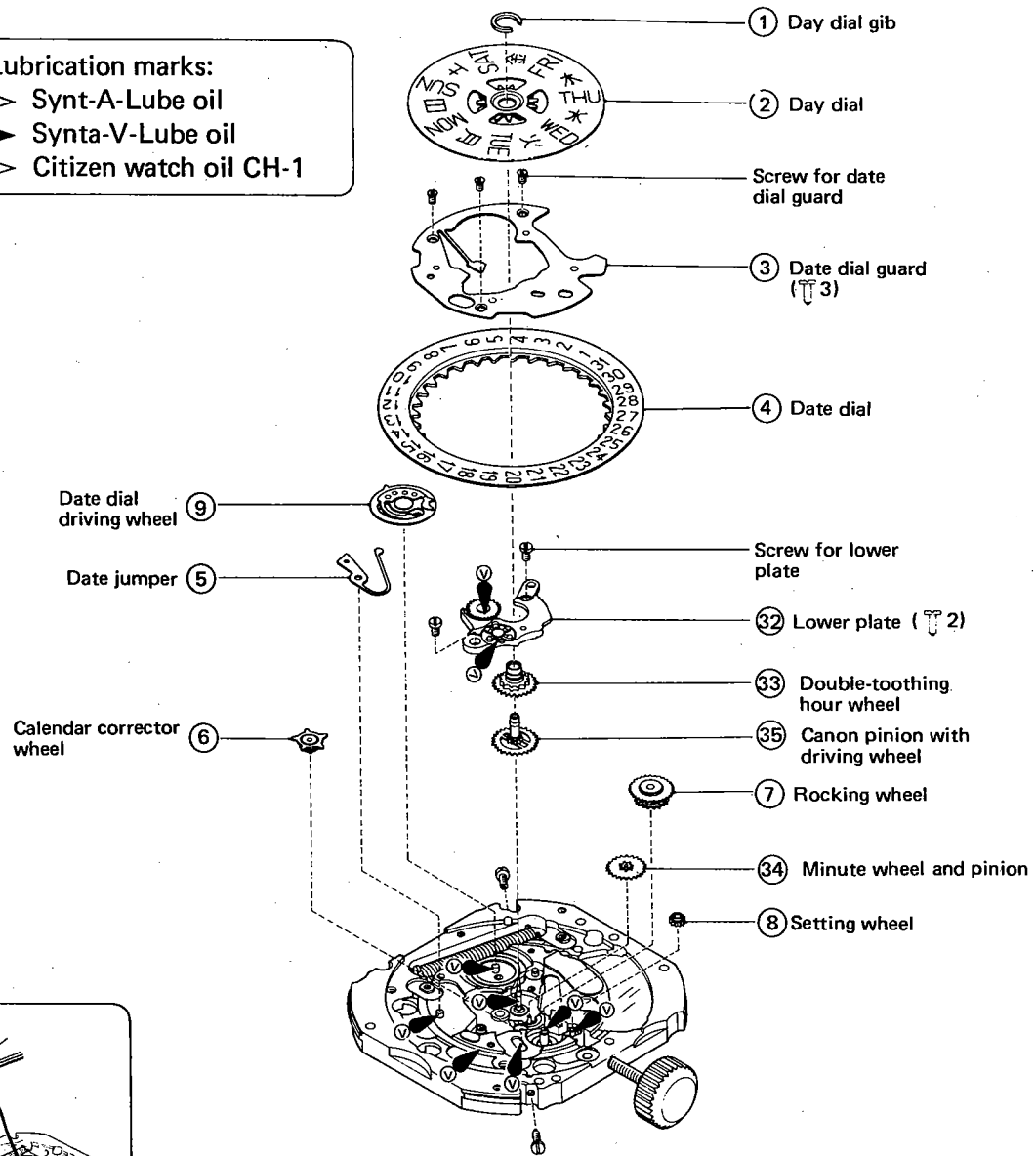

The part of the date dial guard is pinched with a tweezers and then put between the pins of the plate.

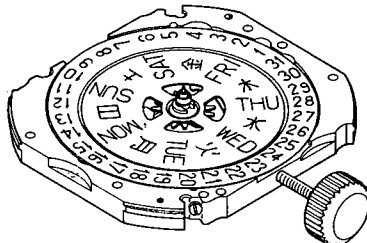

Avoid giving the day setting action with no day dial assembled in order to avoid stretching of the tooth edges between the rocking wheel and the calendar corrector wheel.  
 The quick setting is possible regardless of assembly of the day dial.

2) Power cell side

The notched part of the power cell insulator is fitted to the minus (-) lead plate, and then the power cell insulator is slid laterally to be assembled.

The washing is not usually required for the electronic parts, but the stains or dust must be cleared away to ensure good conductivity.

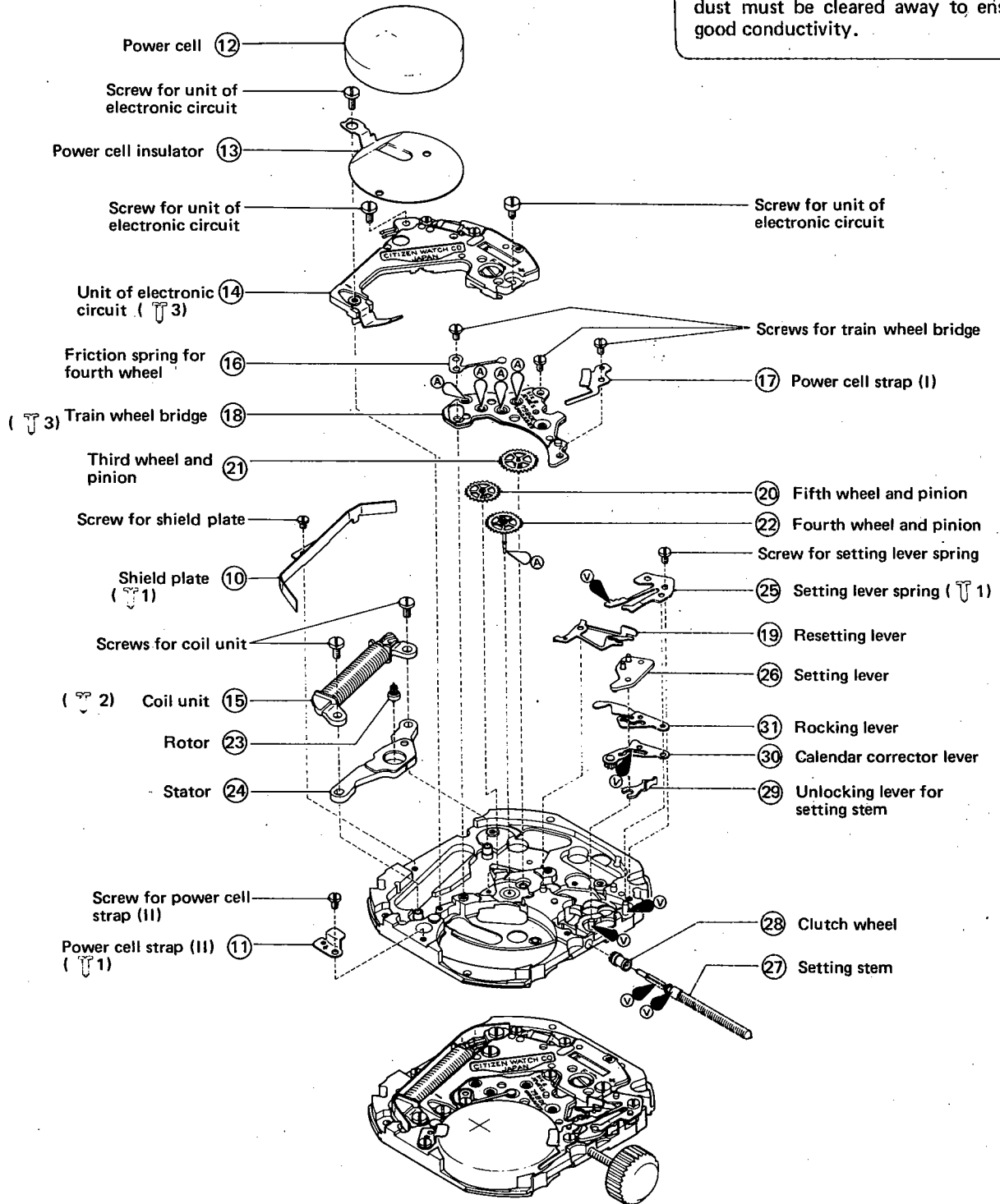

§7. TROUBLESHOOTING AND ADJUSTMENT

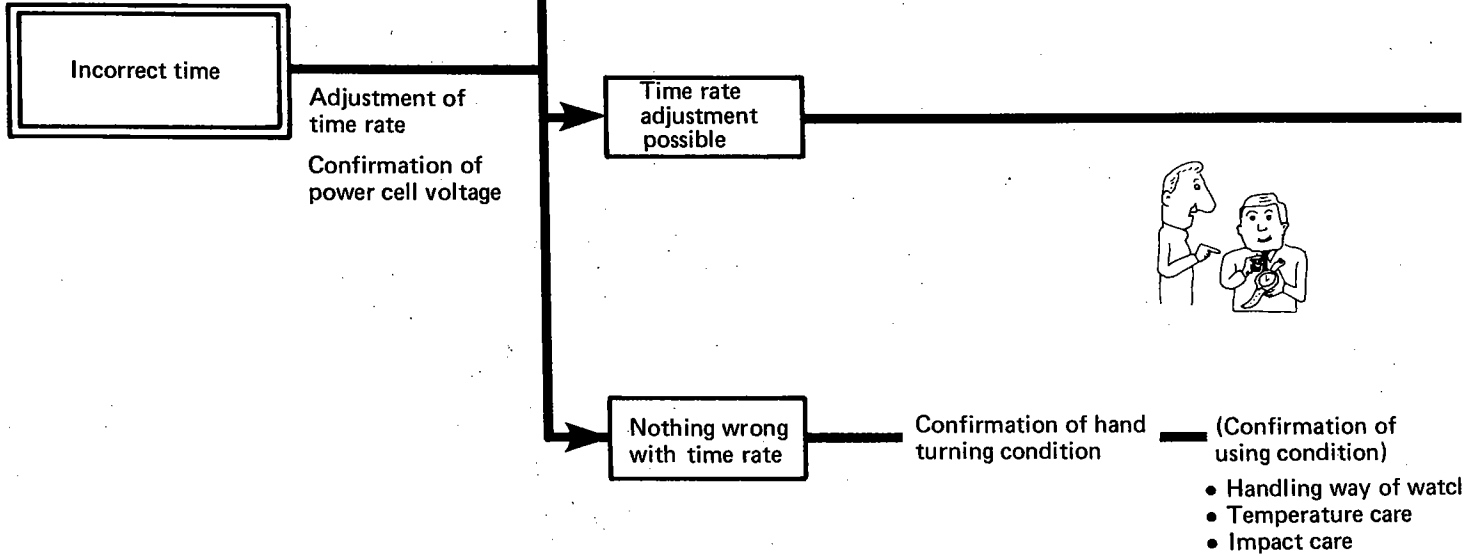
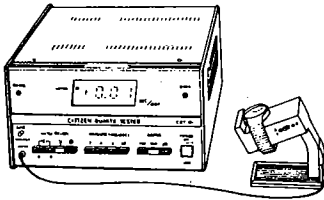
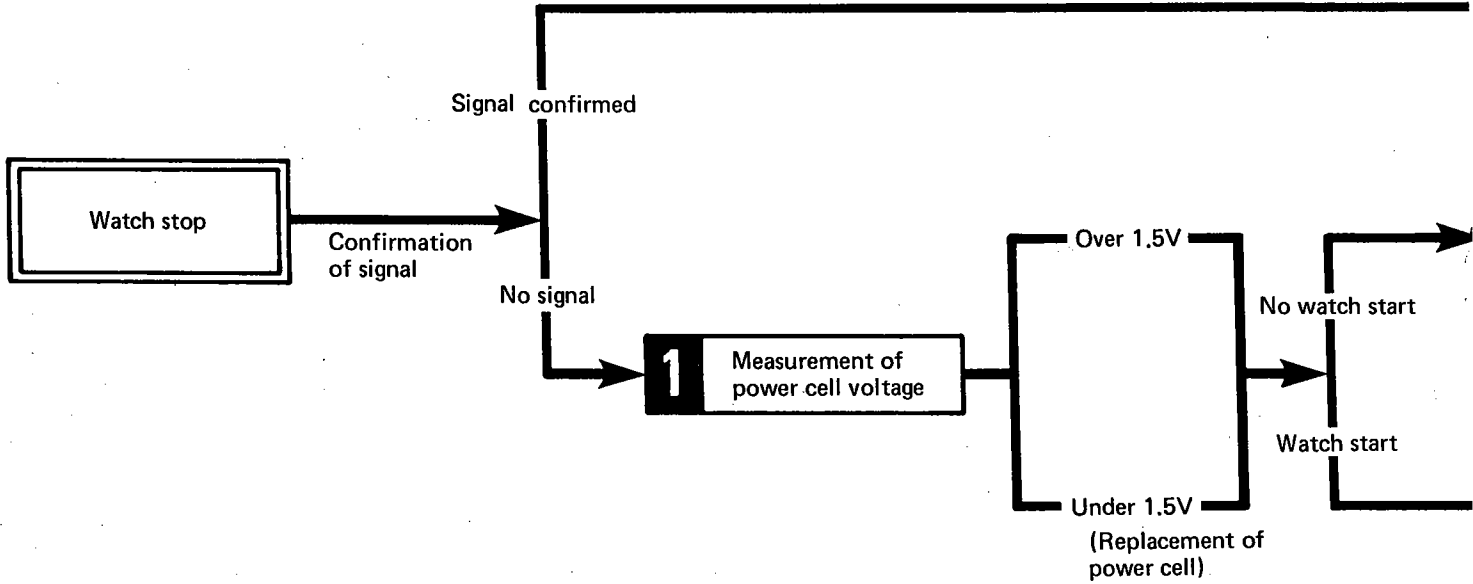

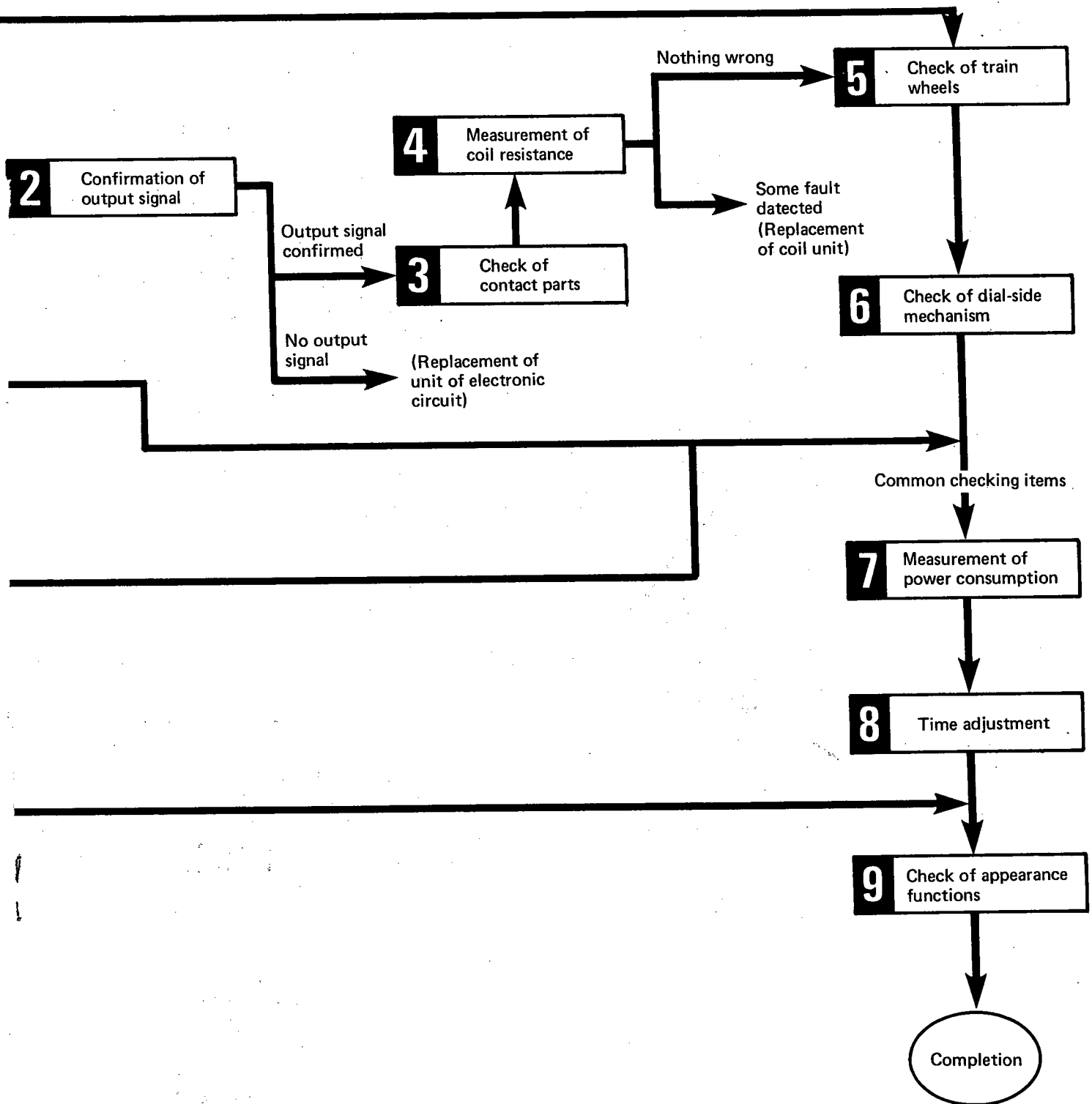

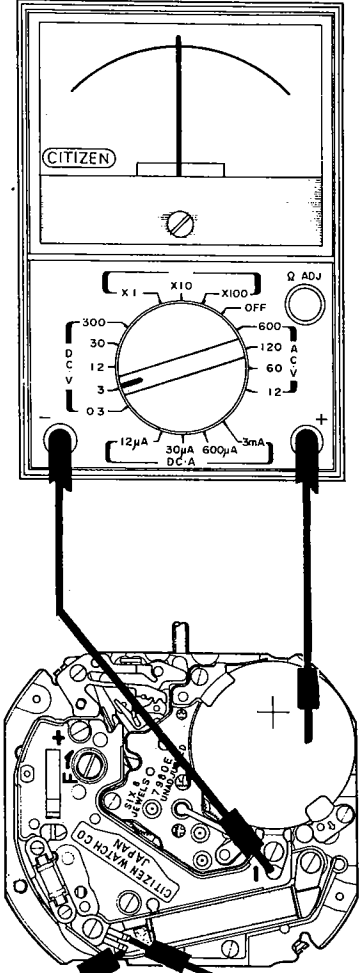
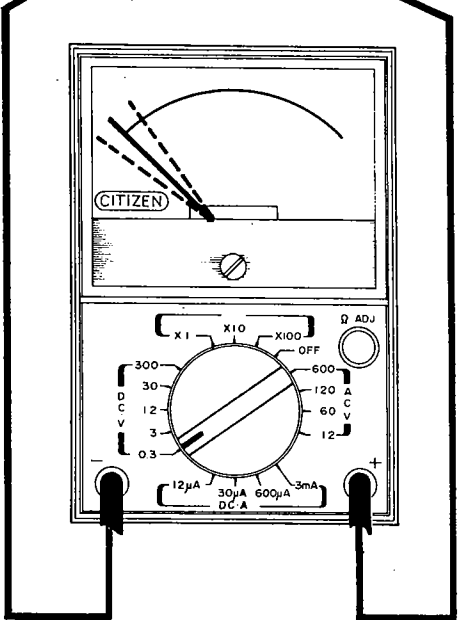

Checking items	How to check	Results and treatment
<p><b>1</b> Measurement of power cell voltage</p>		<p><b>Over 1.5V</b></p> <p>→ Nothing wrong</p> <p><b>Under 1.5V</b></p> <p>→ Replacement of power cell</p> <div style="border: 1px solid black; padding: 5px; margin-top: 10px;"> <p><b>Note</b></p> <p>The power cell, if it has been used more than two years, must be replaced with new one although it reads 1.5V or more output.</p> </div>
<p><b>2</b> Confirmation of output signal</p>		<p>The output signal is confirmed with the movement incorporated.</p> <div style="border: 1px solid black; padding: 5px; margin-top: 10px;"> <p>It is nothing wrong if the pointer of the tester goes and comes back centering on "0".</p> </div> <p>• Some fault detected</p> <p>→ Replacement of unit of electronic circuit</p> <div style="border: 1px solid black; padding: 5px; margin-top: 10px;"> <p>The measurement is facilitated with the shield plate removed.</p> </div>

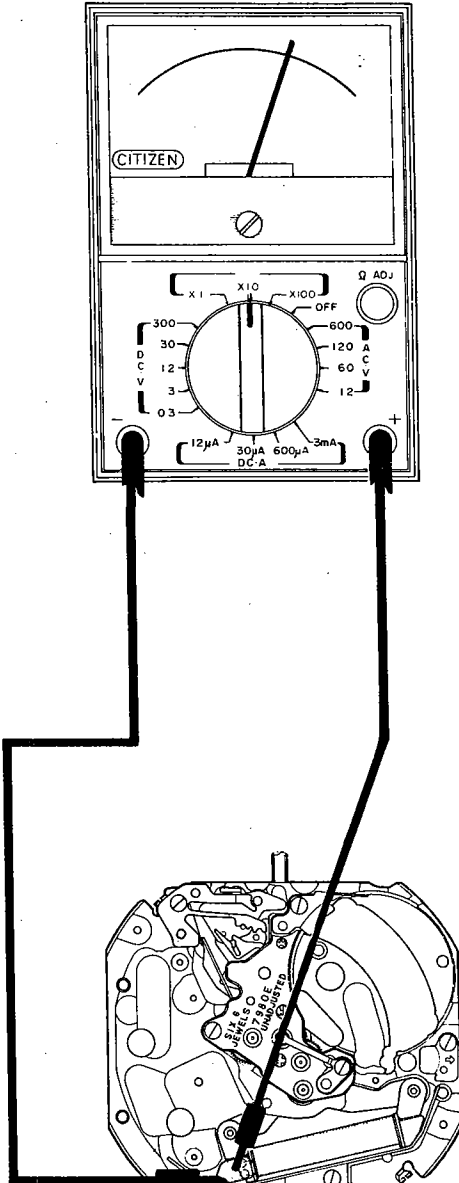
Checking items	How to check	Results and treatment
<p><b>3</b> Check of contact parts</p>	<ul style="list-style-type: none"> <li>• Check whether some dust or stains attaches to the contact part between the unit of electronic circuit and the coil terminal.</li> <li>• Check whether the screw for the unit of electronic circuit is loose.</li> </ul>	<ul style="list-style-type: none"> <li>• Dust or stains attached → Removal</li> <li>• Screw loosened → To be tightened</li> </ul>
<p><b>4</b> Measurement of coil resistance</p>		<p>The readings is within:</p> <p><b>2.2 ~ 2.8KΩ</b></p> <p>→ Nothing wrong</p> <p>The resistance value of <math>\infty\Omega</math> and <math>0\Omega</math> indicates the disconnection and the short-circuit respectively.</p> <p>→ Replacement of coil unit</p> <p>When carrying out the measurement, the unit of electronic circuit is removed and then the terminals of the tester are applied to the areas shown in the left diagram.</p>

Checking items	How to check	Results and treatment
<b>5</b> Check of train wheels	<ul style="list-style-type: none"> <li>• Make sure that the smooth transmission is secured between each wheel with no clearance nor creaking at all.</li> <li>• Make sure an appropriate amount of oil is supplied to each wheel.</li> <li>• Make sure no dust nor other foreign substances stick to each wheel.</li> </ul>	<ul style="list-style-type: none"> <li>• Creaking recognized → Replacement of wheel</li> <li>• Inappropriate amount of clearance → To be correct</li> <li>• Dust and others stuck → To be cleared away</li> </ul>
<b>6</b> Check of dial-side mechanism	<ul style="list-style-type: none"> <li>• Check whether the smooth transmission is secured between the each wheel at the dial side and also whether an appropriate amount of oil is supplied to each area to be lubricated.</li> <li>• Check whether the slip torque of the cannon pinion with driving wheel extraordinarily is high or loose.</li> <li>• Check whether the date and day driving are secured in an assured way and also whether the calendar corrector features its operation with a proper amount of turning force.</li> </ul>	<ul style="list-style-type: none"> <li>• Slip torque of too high or loose → Replacement of cannon pinion with driving wheel</li> </ul>

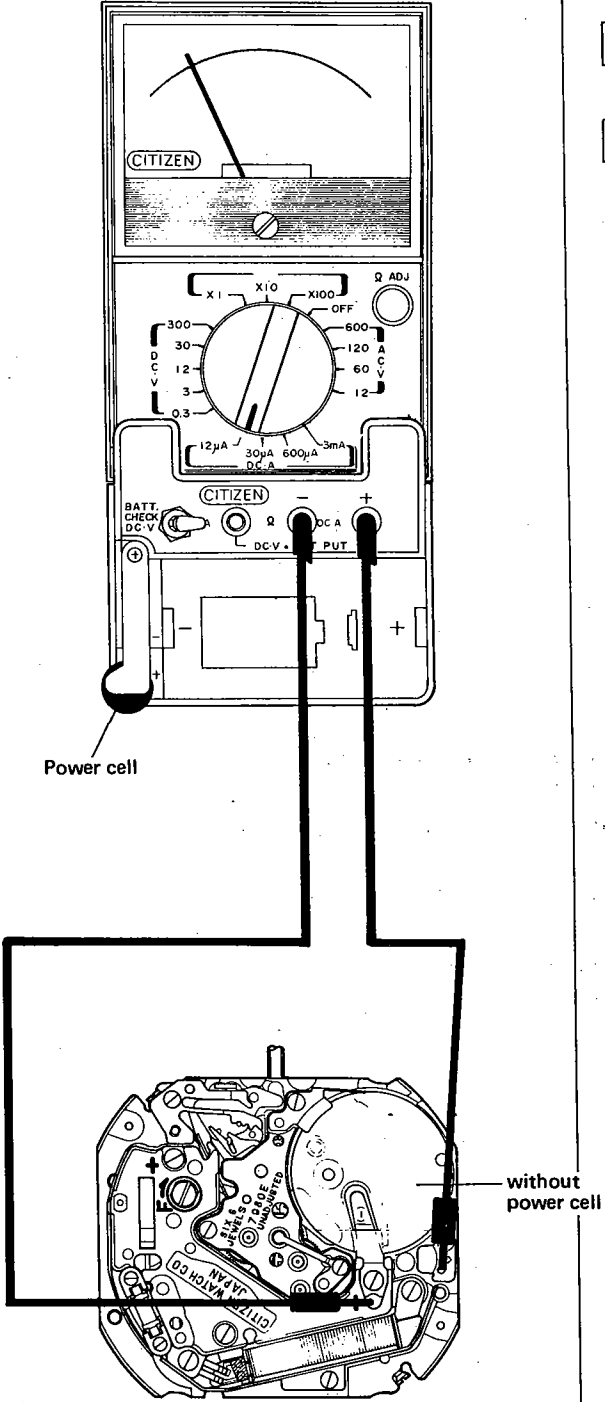
Checking items	How to check	Results and treatment
<p>7 Measurement of power consumption</p>	 <p>The diagram illustrates the setup for measuring power consumption. A CITIZEN multimeter is shown with its dial set to the 12µA range on the DC A scale. The multimeter's probes are connected to a power cell and the watch movement. The watch movement is shown without a power cell, as indicated by the label 'without power cell'.</p>	<p><b>Under <math>2.5\mu\text{A}</math></b>  → Nothing wrong</p> <p><b>Over <math>2.5\mu\text{A}</math></b>  → Replacement of unit of electronic circuit</p>

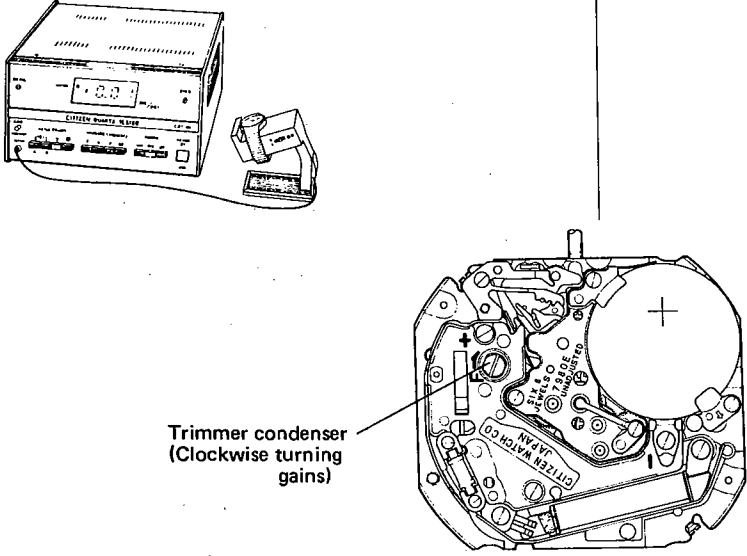
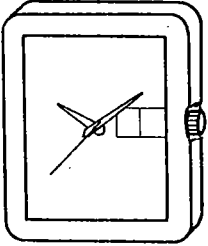
Checking items	How to check	Results and treatment
<p>8 Time adjustment</p>	<ul style="list-style-type: none"> <li>The time rate is measured via the timing machine to perform the time adjustment.</li> </ul>  <p>The diagram shows a timing machine on the left and a detailed view of a watch movement on the right. A line points from the text 'Trimmer condenser (Clockwise turning gains)' to a small component on the movement.</p>	
<p>9 Check of appearance functions</p>	<ul style="list-style-type: none"> <li>Make sure that the second hand features an assured stepped movement.</li> <li>Make sure that the end of the date setting is positioned around 12 o'clock.</li> <li>Make sure that the second hand is stopped in an accurate way.</li> <li>Make sure that no foreign matter sticks onto the surface of the dial.</li> </ul>  <p>The diagram shows a simplified line drawing of a watch face with a date window at the 12 o'clock position and a second hand.</p>	

**CITIZEN WATCH CO., LTD.**

Tokyo, Japan